

# dwell

## Coffee Table

J6327 109864 Black  
109865 Clear

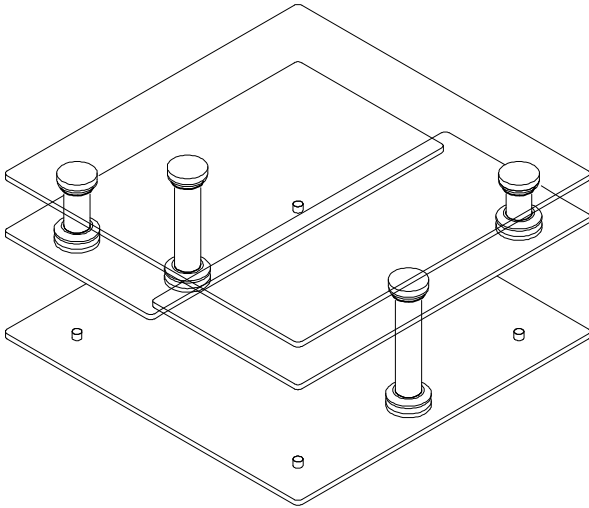

### PLEASE READ

- Please read the assembly Instructions carefully.
- We cannot accept return on any part or fully assembled products.
- Identify each part of the furniture before assembly using the instructions.
- Check all pieces are present and correct.
- Ensure you have all of the correct tools needed for assembly.
- Clear a suitable place to work.  
Never force the fittings together.
- Do not fully tighten any screws until all pieces of the main structure are in place.
- Keep these instructions for future assembly.

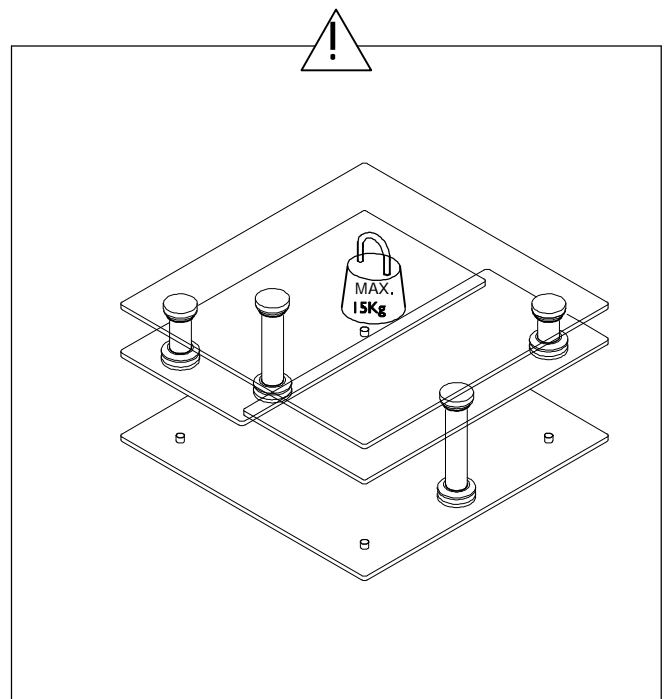
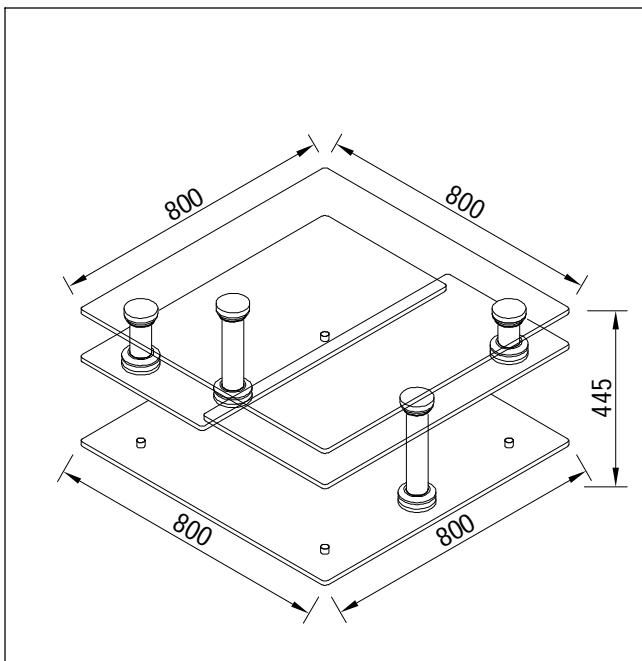
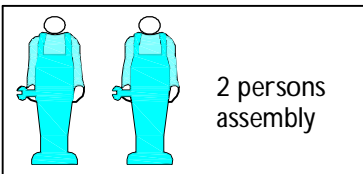

Please keep these instructions for future reference.

If a glass component is chipped or broken, stop using the product and consult the manufacturer or supplier.

### **Warning!**

Do not place very hot or cold items on the glass surface(s) unless adequately thick table mats are used to prevent such items from coming into contact with the glass.

Do not sit or stand upon horizontal glass surface(s).

Do not use the glass as a chopping surface.

Do not strike the glass with hard or pointed items.

Do not use laptops directly on the surface of the glass. Please make sure that a suitable protective mat is used.

When cleaning glass panels use a damp cloth or lather with washing up liquid or soft soap if necessary: do not use washing powders or any other substances containing abrasives since these substances scratch glass.

COMPONENTS

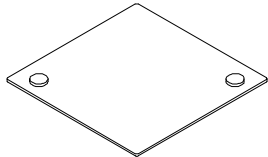
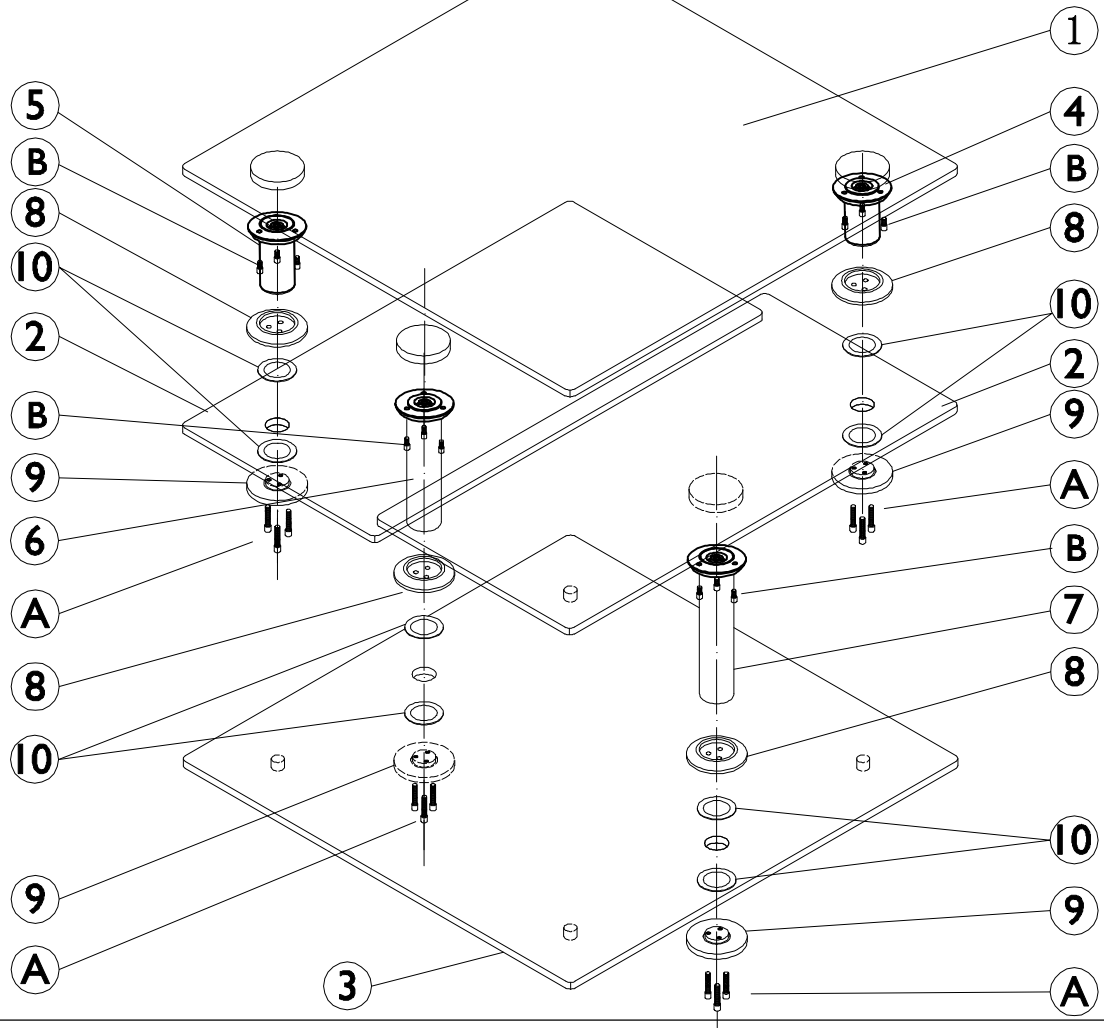

① X1  
Large Top Glass

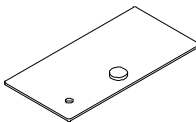

② X2  
Small Top Glass

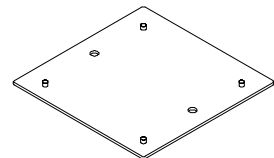

③ X1  
Glass Base



④ X1  
70mm Upper Short Pole

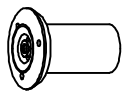

⑤ X1  
100mm Upper Long Pole

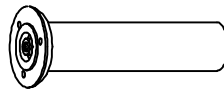

⑥ X1  
207mm Lower Short Pole

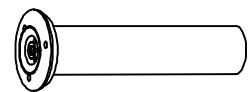

⑦ X1  
237mm Lower Long Pole



⑧ X4  
Pole Skirt



⑨ X4  
Pole Base



⑩ X8  
Washer

TOOLS NEEDED



5#

HARDWARE



Ax12  
M6X40



BX12  
M6X12

1 ▷

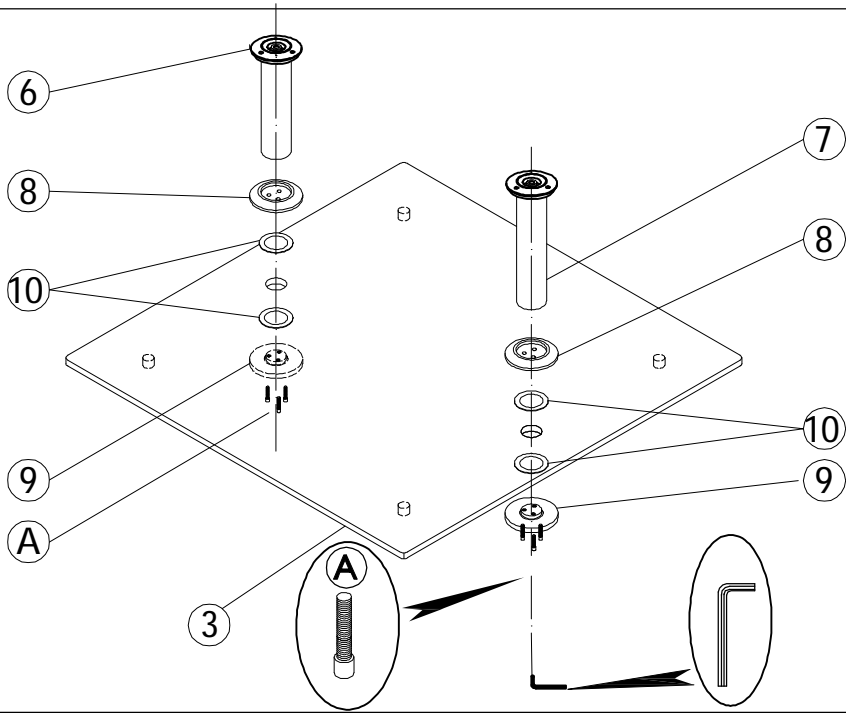

TOOLS NEEDED

II



5#

HARDWARE



Ax12  
M6X40



BX12  
M6X12

2 ▷

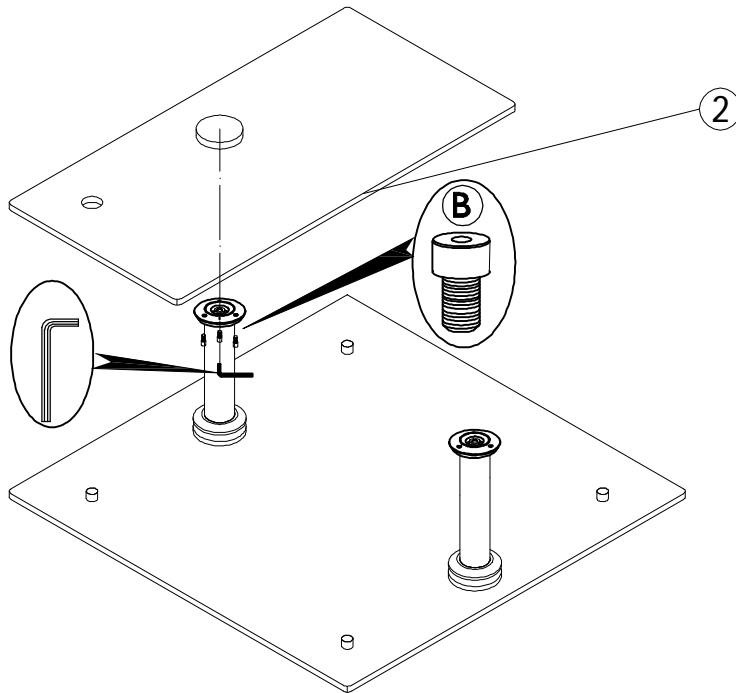

3 ▷

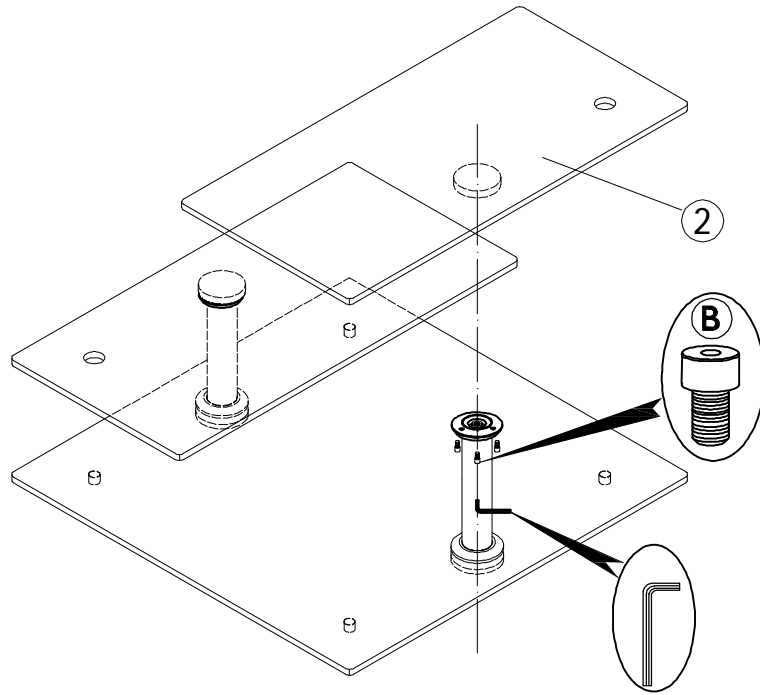

TOOLS NEEDED



5#

HARDWARE



Ax12  
M6X40



BX12  
M6X12

4 ▷

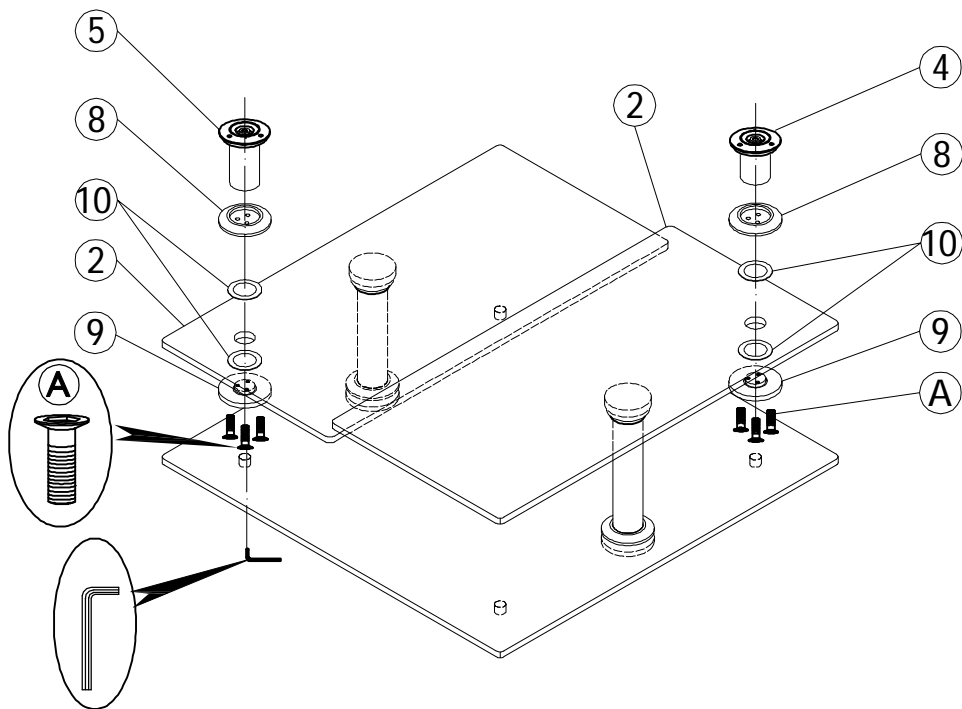

5 ▷

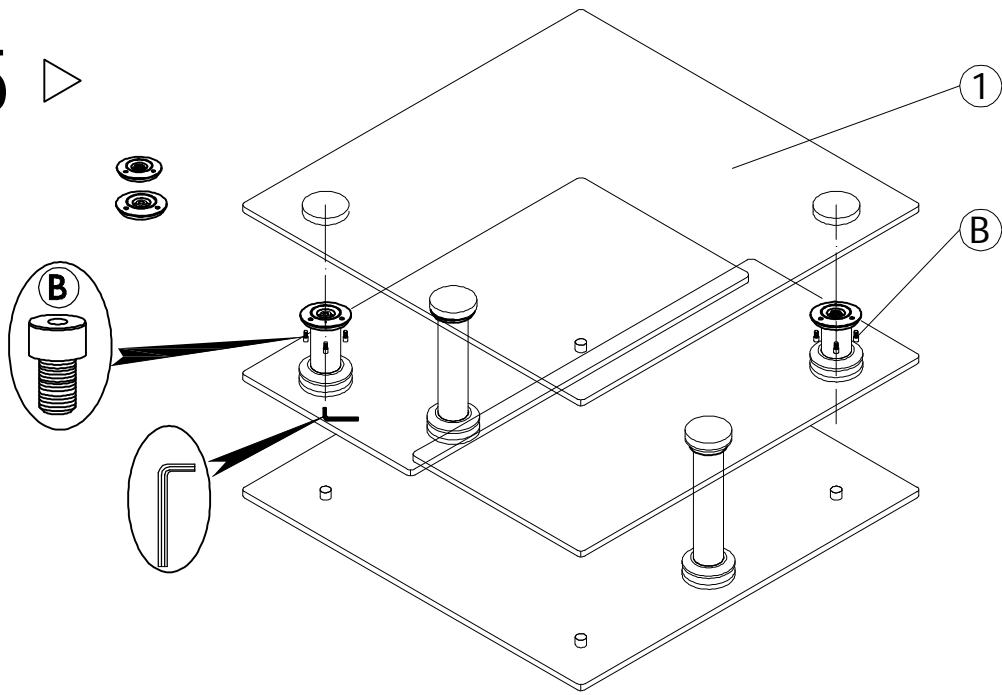

TOOLS NEEDED



5#

HARDWARE



Ax12  
M6X40



BX12  
M6X12

6 ▷

